

Assembly Manual

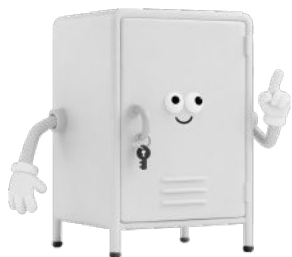

Item: Outdoor Waste Bin Box, 1 Bin



Dear Customer,
Thank you for choosing our product! This manual covers accessories, installation steps and safety notes.
Enjoy your experience!



60 – 90 min



Check the quantity of parts

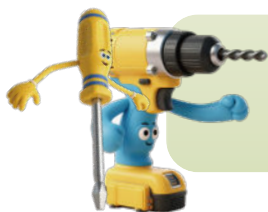

Prepare the tools



On-carpet installation

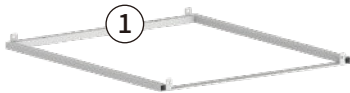
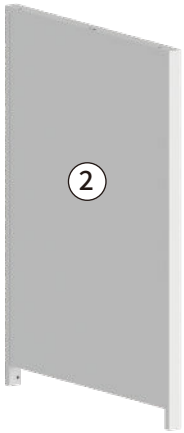

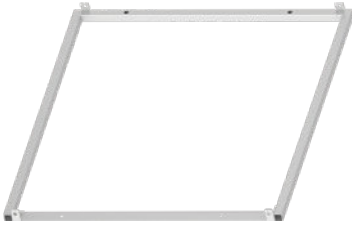

1 Bottom Frame
1x



2 Side panel, Left
1x



3 Side panel, Right
1x



4 Back panel
1x



5 Top cover panel
1x



6 Handle
1x



7 Door
1x



G24 Screws
24x



G25 Screws
4x



G27 Screws
2x



G26 Screws
6x



G28 Screws
3x



A13 Bolt
4x



A14 Hinge
2x



A15 Damper
2x



A16 Cover cap
4x



A17 Magnet
2x



A18 Metal hook
1x



A20 Metal string
1x



A19 Lock
1x



T10 Wrench
1x



L60 Pad
2x

1

A16
4x

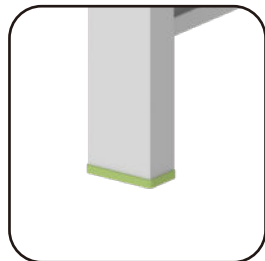
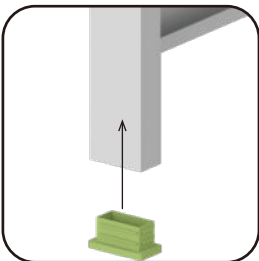
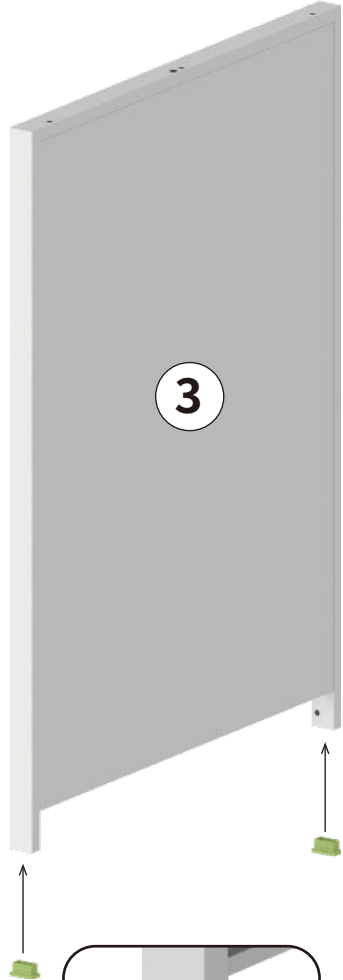

2

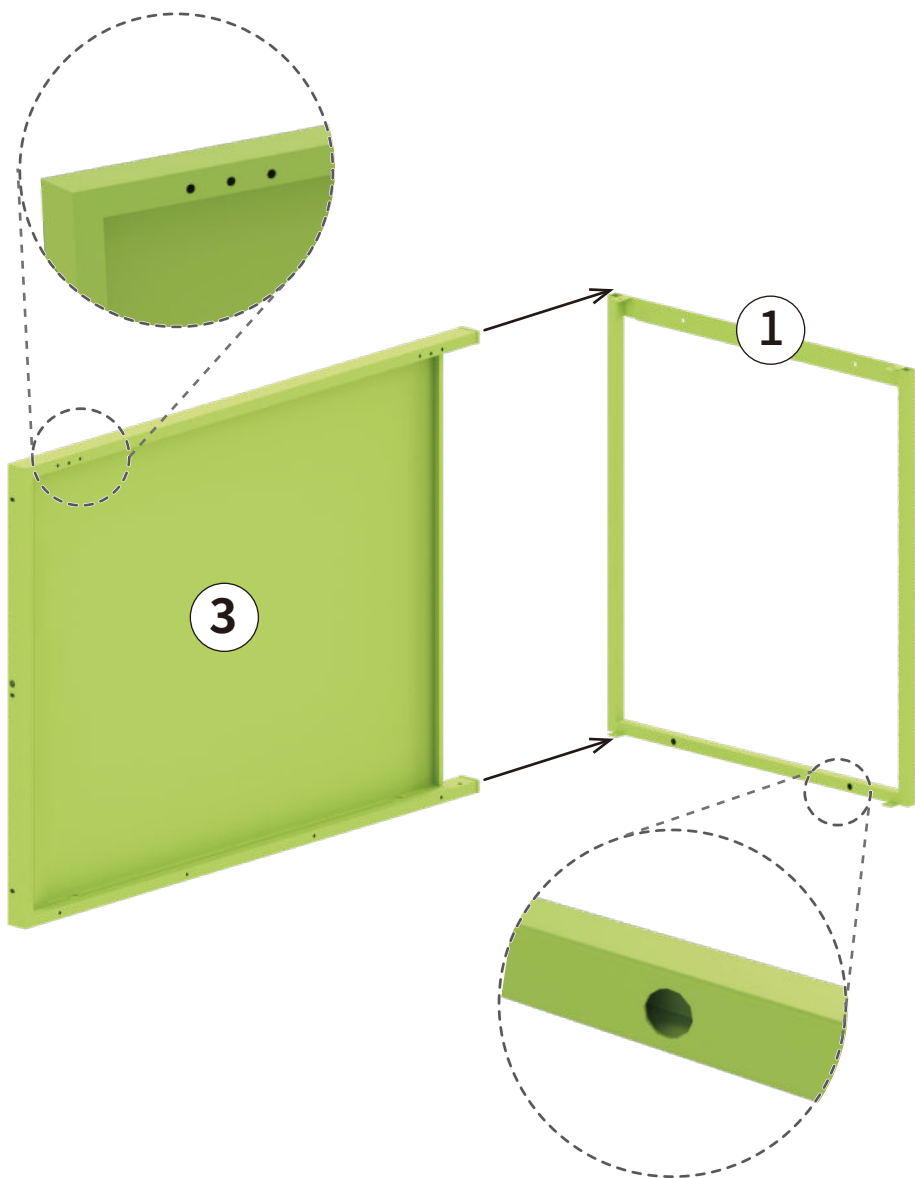

3

G25
2x

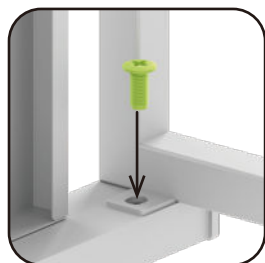
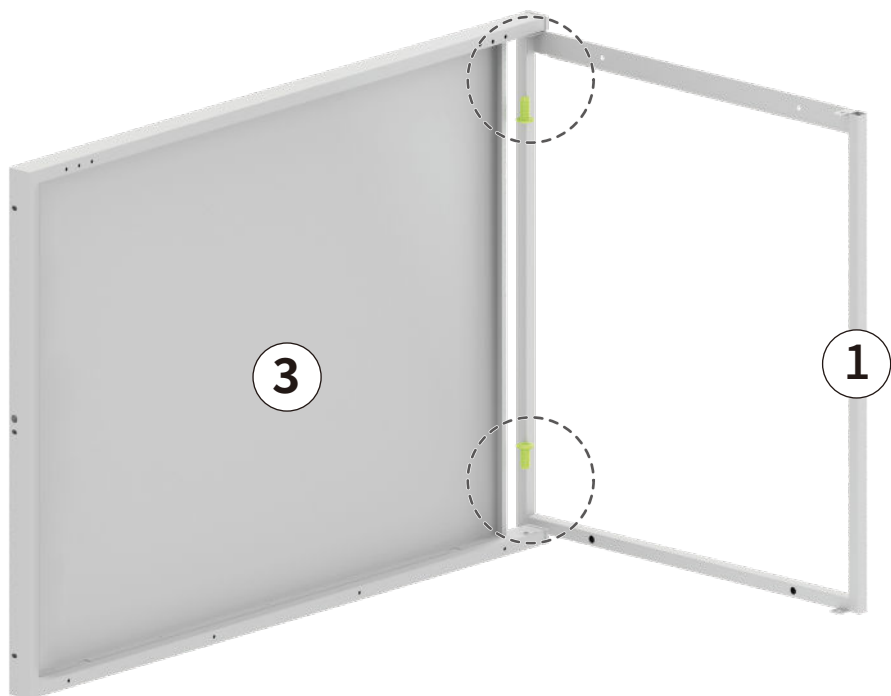

4

G25
2x

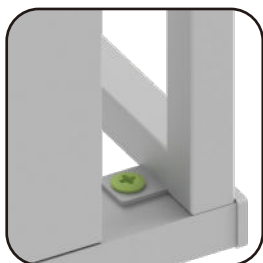
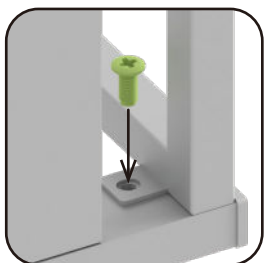
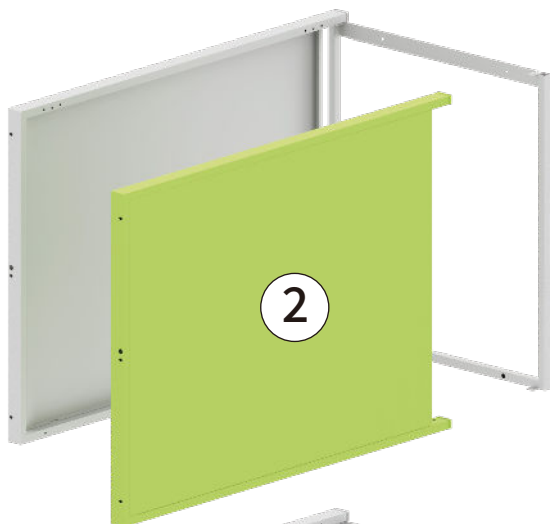

5

G24

8x

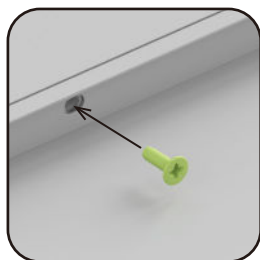
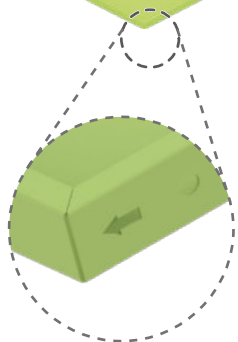
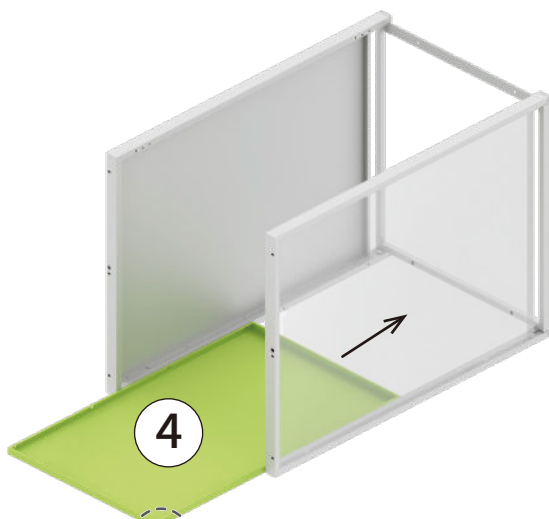

6

A17
2x



G24
4x

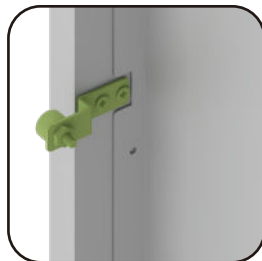
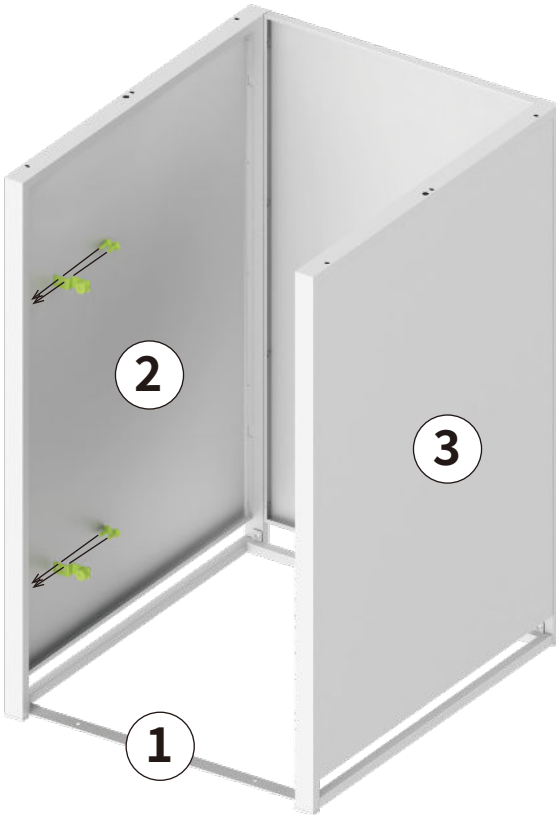

7

6
1x



G27
2x

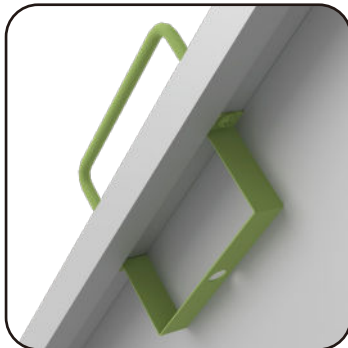
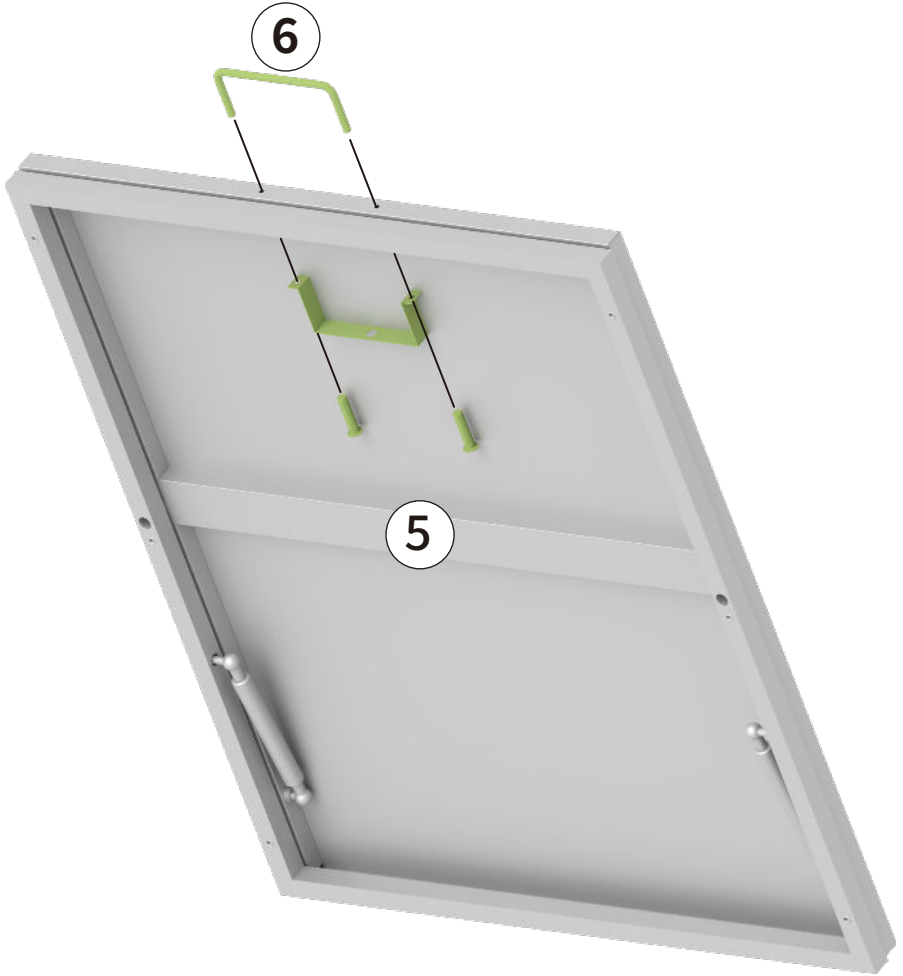

8

T10

1x

G26

6x



9

A15
2x

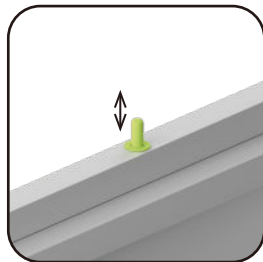
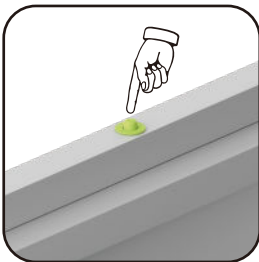

10

A14
2x



G24
6x

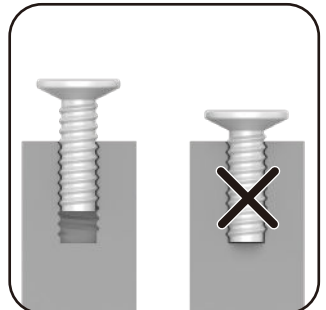
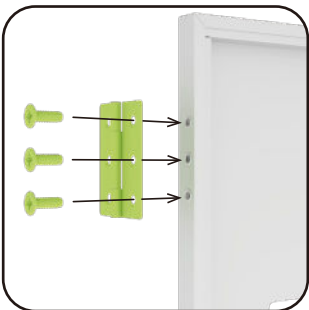
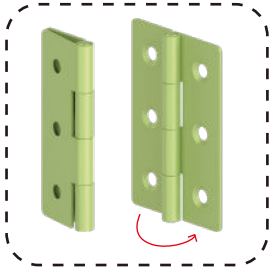

11

G24
6x

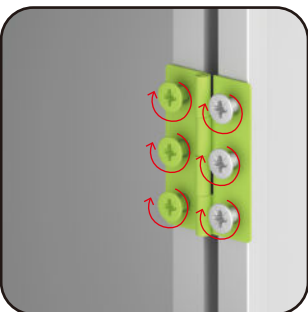
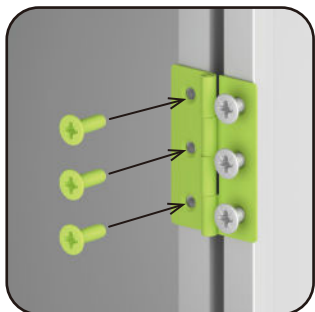

12

G28
3x



A19
1x

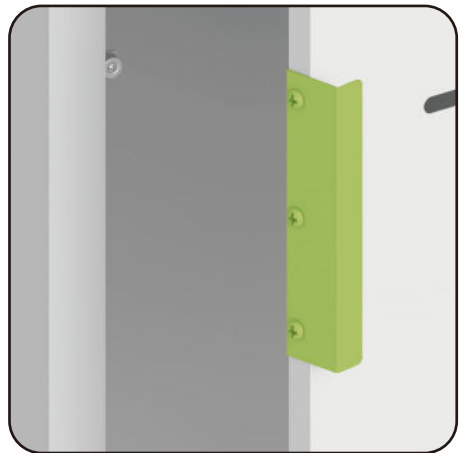
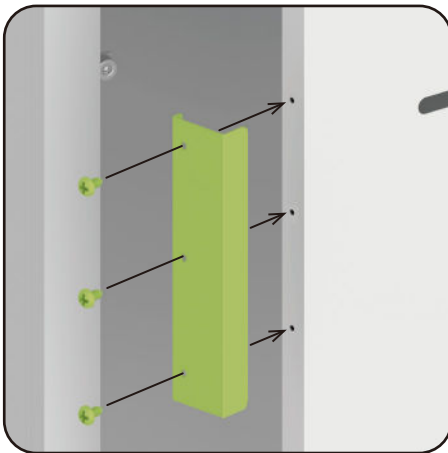

13

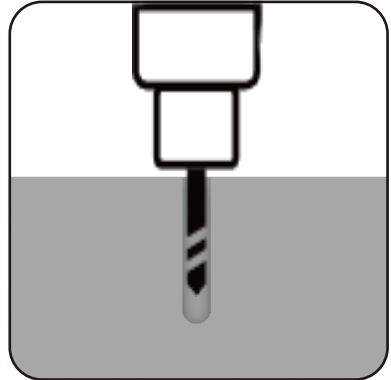
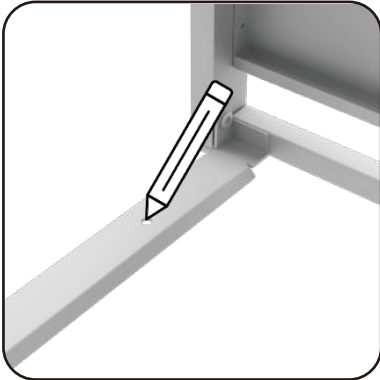

14

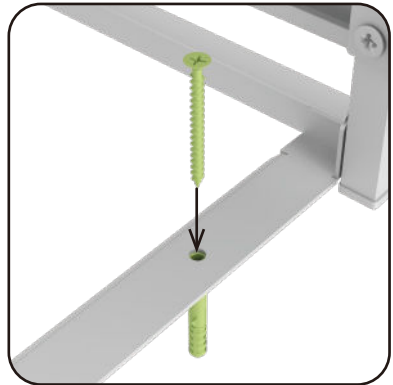
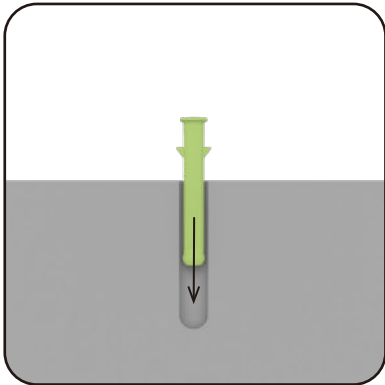
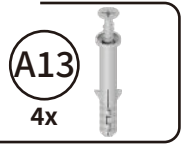

15

L60
2x

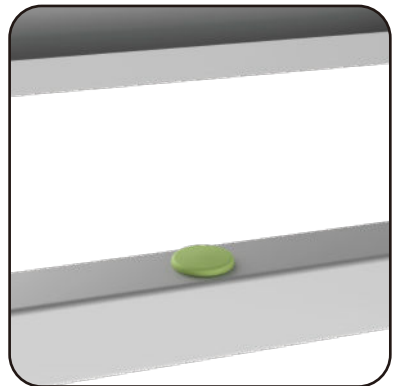
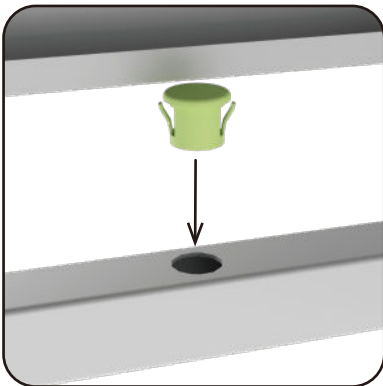

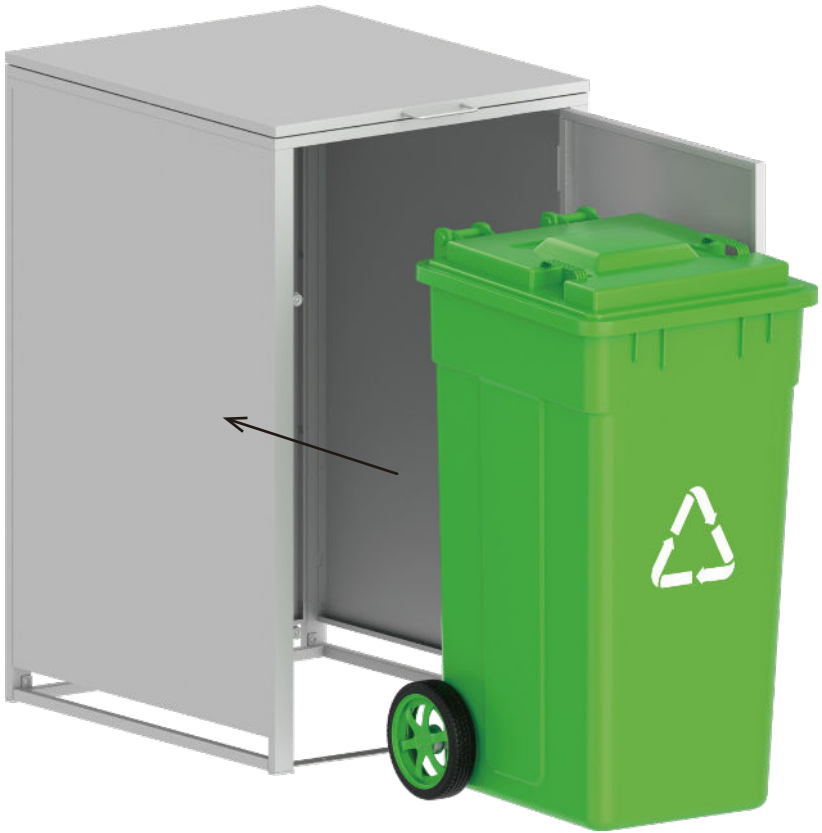

17

A18
1x



A20
1x

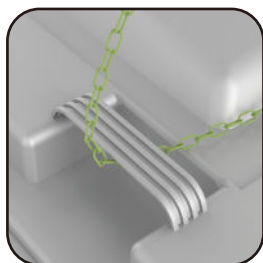



Complete!

